

K4 servo drive systems

Brilliantly versatile

Drive solutions | Industrial drive engineering

Product Catalogue 2020-02

ebmpapst

the engineer's choice

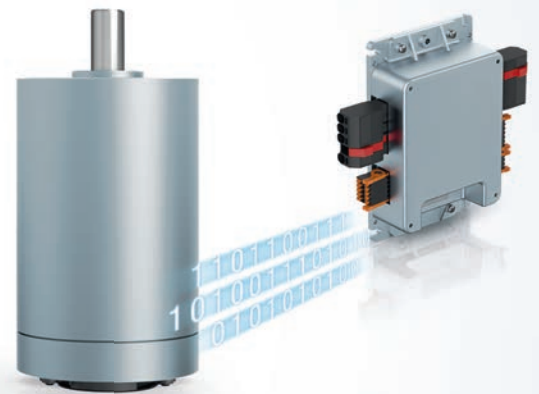

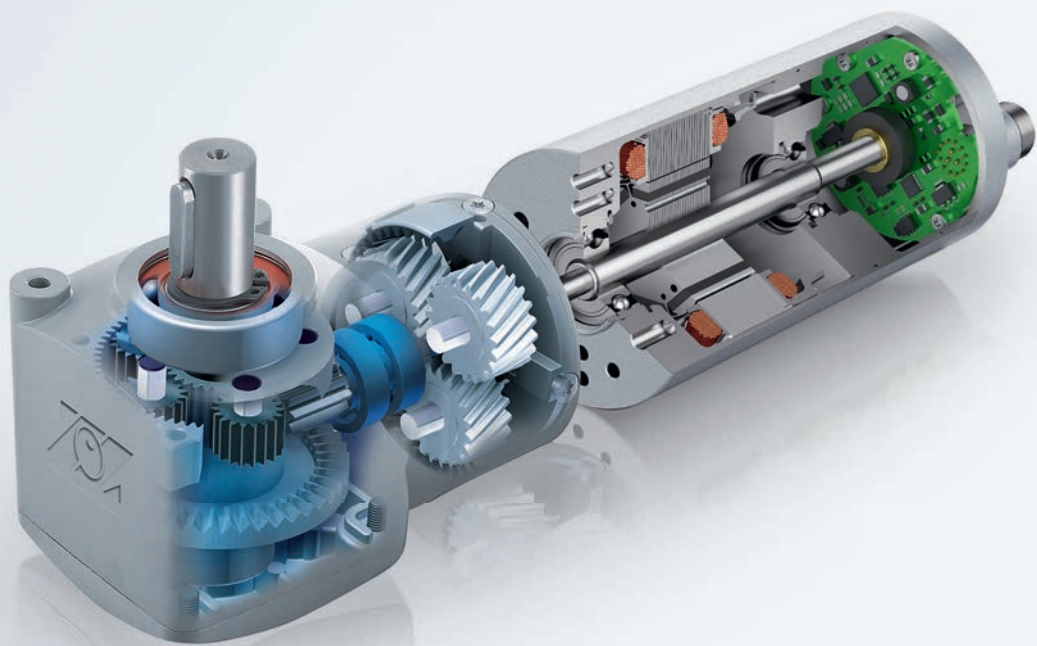

Modular drive systems.
Motors with integrated logic and power
electronics – optional gearhead, encoder and brake.

Contents

K4 servo drive systems

model series ECI und VDC

ebmpapst

the engineer's choice

	Page		Page
Information	4	About ebm-papst / Green Intelligence	4
		The story of our success	5
		The K4 can do (almost) everything.....	6
K4 servo drive	8	VDC-49.15-K4	10
		ECI-63.XX-K1	14
K1 servomotor in combination with external control electronics	18	ECI-80.XX-K1	20
		VDT-XX.XX-K4S (position)	21
Commissioning	26	The K4 can do (almost) everything	26
		Easy integration into Profinet networks.	27
		Agents around the world	28

Information

K4 servo drive

K1 servomotor

Commissioning

Agents

About ebm-papst.

ebm-papst is a leader in ventilation and drive engineering technology and a much sought-after engineering partner in many industries. With around 20,000 different products, we have the perfect solution for practically every requirement. We believe the consistent further development of our highly-efficient GreenTech EC technology provides our customers with the best opportunities for the future in industrial digitization. With GreenIntelligence, ebm-papst already offers intelligent networked complete solutions that are unique anywhere in the world today.

Six reasons that make us the ideal partner:

Our systems expertise: as experts in advanced motor technology, electronics and aerodynamics, we provide system solutions from a single source.

Our spirit of invention: our 600 engineers and technicians will develop a solution that precisely fits your needs.

Our lead in technology: with our EC technology and GreenIntelligence, we combine the highest energy efficiency with the advantages of IoT and digital networking.

Closeness to our customers: at 49 sales offices worldwide.

Our standard of quality: our quality management is uncompromising, at every step in every process.

Our sustainable approach: we assume responsibility with our energy-saving products, environmentally-friendly processes, and social commitment.

GreenIntelligence. *Making Engineers Happy.*



Why do our customers look so happy? Because when it comes to the Internet of Things and the digital transformation, we provide them with a clear competitive edge with GreenIntelligence for intelligent control and interconnection of fans, drives and systems to make applications more powerful, processes more efficient, businesses more successful and their customers more satisfied.

For the wide range of automation tasks needed in **industrial drive technology**, what you need most is an experienced partner who understands your needs. The drive experts at ebm-papst have detailed applications expertise and, thanks to GreenIntelligence, can offer drive solutions with intelligent networking capabilities that cater for all requirements perfectly.

Here is how much GreenIntelligence there is in ECI Motors:

- integrated logic & power electronics
- network functionality
- Master/slave functionality
- Condition monitoring
- Predictive maintenance



Anna exploits the possibilities of the Industrial Internet of Things throughout her logistics and production processes.

The story of our success *to market and technology pioneer.*

- 1963** Founding of **Elektrobau Mulfingen GmbH & Co. KG** by Gerhard Sturm and Heinz Ziehl.
- 1965** First tubeaxial fan developed in EC-/DC technology.
- 1966** ebm`s success takes off with the new 68 motor.
- 1972** The first ebm foreign subsidiary is established in Sweden.
- 1988** Gerhard Sturm is awarded the Federal Cross of Merit.
- 1990** The sixty millionth external rotor fan was produced .
- 1992** Acquisition of **PAPST Motoren GmbH** in St. Georgen.
- 1997** Buyout of the **Landshut** (mvl) plant.
- 2003** Change of name to **ebm-papst**.
- 2007** Introduction of the gearhead "**EtaCrown®**".
- 2010** **GreenTech** – our sign for energy efficiency and resource preservation.
- 2012** Introduction of a new generation control electronics (**K4**) for BLDC motors.
- 2013** ebm-papst acquires the gear specialist, **Zeitlauf**, and wins the **German Sustainability Award**.
- 2014** Launch of the BLDC internal rotor servomotor, **ECI 80**.
- 2015** Introduction of the overload-capable planetary gear "**Optimax 63**".
- 2016** Expansion of the electronic production plant, St. Georgen **Hagenmoos**.
- 2017** Introduction of **intelligent compact drives** with bus interface K5
- 2018** **GreenIntellegence** – our symbol for high efficient and network capable BLDC drives.

The K4 can do (almost) everything ...

Basic functions of K4 electronics

- Speed, torque and positioning control for BLDC motors

Benefits for you with K4 electronics

- Excellent control mode using field-oriented control
- Choice of operating modes and parameters using RS485
- Extensive interface with various inputs and outputs
- Activation of the power amplifier via digital input
- Integrated braking chopper function
- Set rotation speed control range from $n = 0$ U/min (with holding torque) up to max. speed (depending on motor)
- High efficiency and power density in compact construction

Up to 750 Watts power output

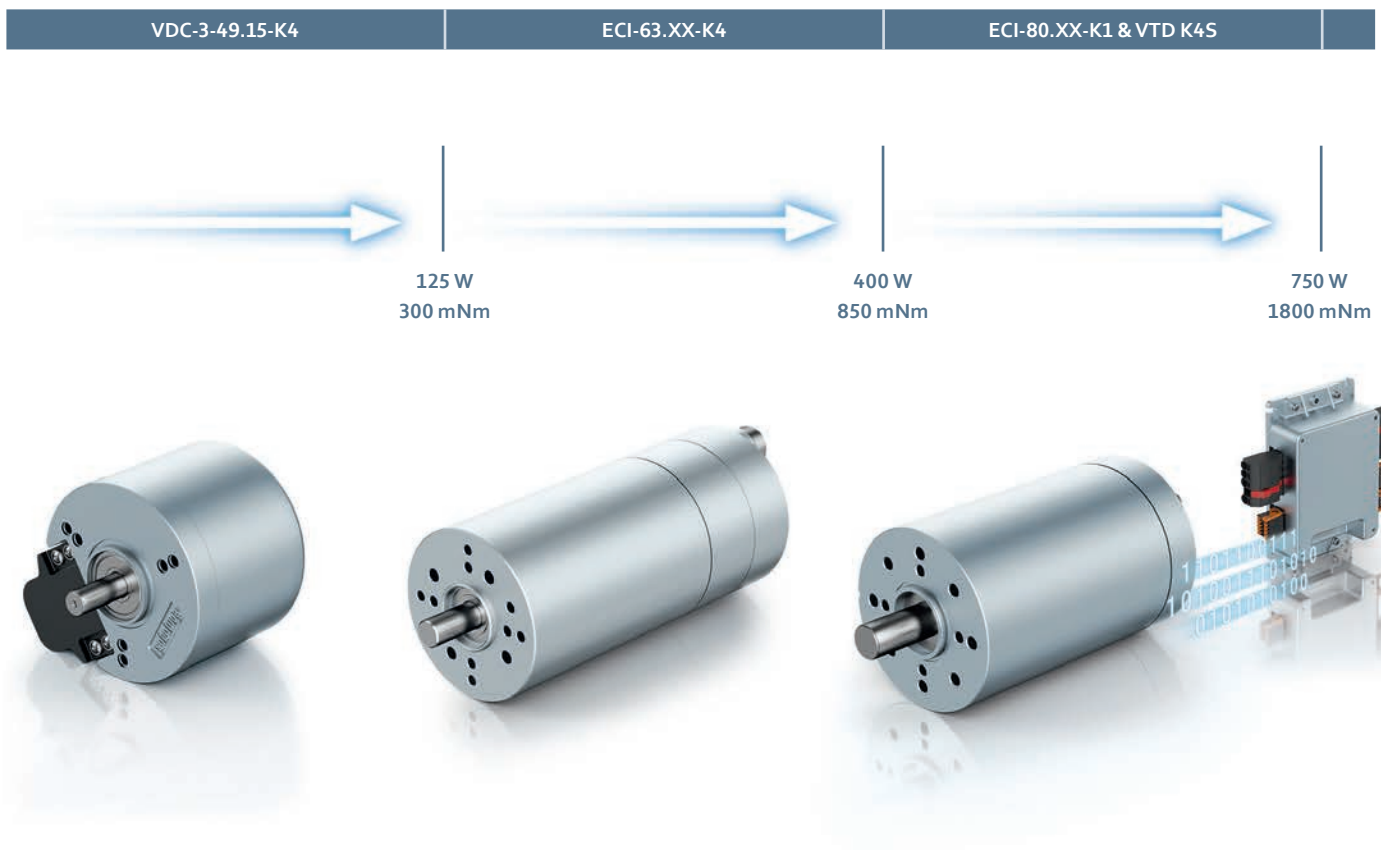

Operating it is like child's play

- Parameterization and commissioning using PC software „driveSTUDIO“
- Intuitive operation even without knowledge of programming languages
- No BUS knowledge required





K4 servo drive

ebmpapst

the engineer's choice

	Page
VDC-49.15-K4	10
ECI-63.XX-K4	14

Servo drive VDC-49.15-K4



K4 servo drive



Description

- 3-phase BLDC external rotor motor
- High-poled motor structure for optimum power density
- Drive with completely integrated K4 operation and control electronics
- Integrated speed, torque and position control
- Parameter setting via RS485
- Interface with analog and digital control inputs
- Integrated brake chopper
- Robust mechanical design in IP 54 for industrial applications

More at www.ebmpapst.com/eci-motoren

Type		VDC-49.15-K4-B00	VDC-49.15-K4-D00
Characteristic curve		A	B
Nominal voltage (U_N)	V DC	24	48
Nominal speed (n_N) ³⁾	rpm	4 000	4 000
Nominal torque (M_N) ³⁾	mNm	235	300
Nominal current (I_N) ³⁾	A	5.20	3.20
Nominal output power (P_N) ³⁾	W	99.0	126
Starting torque (M_A)	mNm	705	900
Permissible peak current (I_{max}) ²⁾	A	15.6	9.60
Speed at no-load operation (n_0)	rpm	5 000	5 000
No-load current (I_0)	A	0.40	0.25
Recommended speed control range	rpm	0 ... 4 000	0 ... 4 000
Rotor moment of inertia (J_R)	kgm ² x10 ⁻⁶	108	108
Overload protection		Integriert	Integriert
Permissible ambient temperature range (T_U)	°C	0 ... +40	0 ... +40
Weight	kg	0.59	0.59
Part number ¹⁾	IP54	937 4915 400	937 4915 402

¹⁾ The degree of protection refers to the installed condition with sealing on the flange side

The shaft geometry in the IP54 version is different from the displayed sketch

²⁾ Permissible time for peak current: max. 1 sec. – to be repeated only after complete cool down

³⁾ At T_U max. 40 °C

Preferred type: ready to ship in 48 hours

Subject to alternations

A VDC-49.15-K4-B00 (at 25 °C)

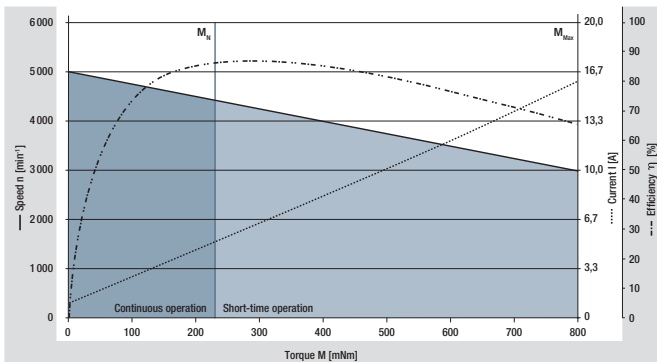

B VDC-49.15-K4-D00 (at 25 °C)

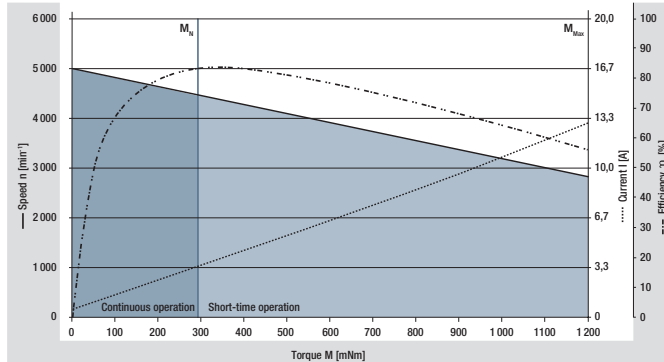

K4 servo drive

Modular system

Commissioning tool

"driveSTUDIO" Seite 26

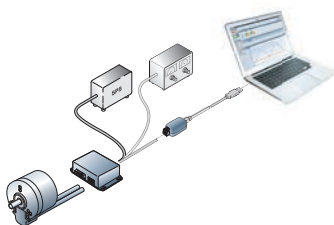

Basic motor



Planetary gearhead

- NoiselessPlus 63
- Performax® 63
- Performax®Plus 63

Crown gearheads

- EtaCrown® 75
- EtaCrown®Plus 63

Spur gearheads

- Compactline 91
- Flatline 85

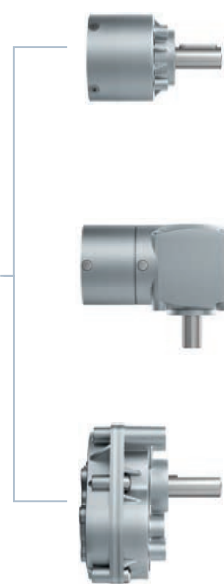

For motor-gearbox combinations, depending on the choice of the single components, the maximum allowable torque (gearbox) can be exceeded or respectively not reached.

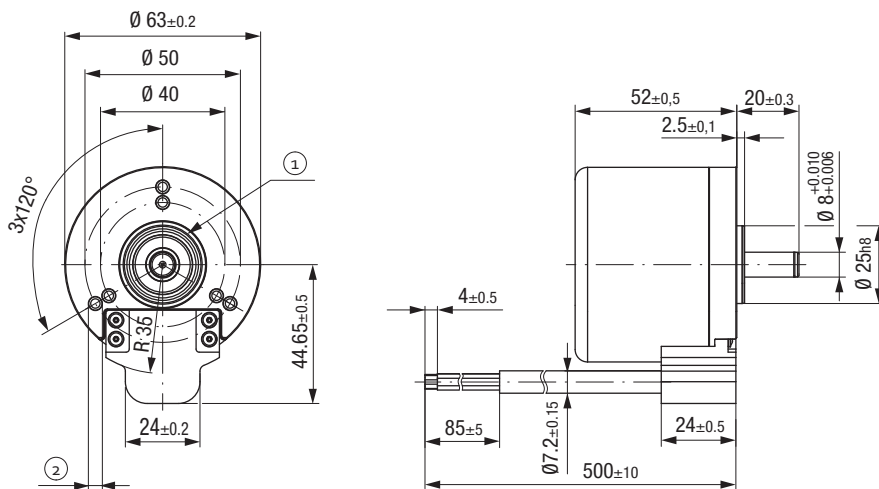

- ① Grooves for o-ring
- ② 6 x For thread-rolling screws according M4 to DIN7500

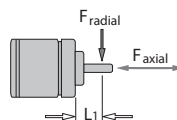

Permissible shaft load

F_{axial} :	20 N	Permissible simultaneous shaft loads at rated speed and service life expectancy L_{10} (in rated operation) from 20 000 h (at T_U max. 40 °C)
F_{radial} :	60 N	
L_1 :	10 mm	

Electrical connection

	Pin	Wire color	Configuration	Function	recommended AWG
Signal	1	white	D-IN-A	Digital input A	24
	2	brown	D-IN-B	Digital input B	
	3	green	D-IN-1	Digital input 1	
	4	yellow	D-IN-2	Digital input 2 Analog 0 ... 10 V / brake	
	5	gray	D-OUT-1	Digital output 1	
	6	pink	D-OUT-2	Digital output 2	
	7	-	-	not used	
	8	red	A-IN-1	0 ... 10 V (differential)	
	9	black	A-IN-GND	Ground for analog IN 1 (differential)	
	10	violet	RS485 A (+)	Prog.-bus	
	11	gray / pink	RS485 B (-)	Prog.-bus	
	12	red / blue	U_{Logic}	Logic power supply (24 V)	
Power	A	gray	Ballast	Ballast resistor	16
	B	brown	U_{ZK}	Power supply	
	C	black	GND	Power- / signal-ground	

Subject to alternations

Servo drive ECI-63.XX-K4



K4 servo drive



Description

- 3-phase BLDC internal rotor servomotor
- Excellent control behavior via field oriented control with sine commutation
- High-poled motor structure for optimum power density
- Drive with completely integrated K4 operation and control electronics
- Integrated speed, torque and position control
- Parameter setting via RS485
- Interface with analog and digital control inputs
- Integrated brake chopper
- Robust mechanical design in IP 54 for industrial applications

More at www.ebmpapst.com/eci-motoren

Type		ECI-63.20-K4 -B00	ECI-63.20-K4 -D00	ECI-63.40-K4 -B00	ECI-63.40-K4 -D00	ECI-63.60-K4 -D00
Characteristic curve		A		B		C
Nominal voltage (U_N)	V DC	24	48	24	48	48
Permissible supply voltage range (U_{ZK})	V DC	18 ... 30	18 ... 53	18 ... 30	18 ... 53	18 ... 53
Max. reverse voltage	V DC	35	58	35	58	58
Nominal speed (n_N)	rpm	4 000	4 000	4 000	4 000	4 000
Nominal torque (M_N) ²⁾	mNm	425	450	600	750	850
Nominal current (I_N) ²⁾	A	8.50	5.40	12.3	7.20	8.60
Nominal output power (P_N) ²⁾	W	178	188	251	314	356
Starting torque (M_{max})	mNm	1 480	1 890	1 500	3 000	2 550
Speed at no-load operation (n_L)	rpm	5 800	5 800	5 900	5 800	6 000
No-load current (I_L)	A	0.50	0.50	0.90	0.50	0.60
Recommended speed control range	rpm	0 ... 5 000	0 ... 5 000	0 ... 5 000	0 ... 5 000	0 ... 5 000
Set value input		analog / PWM / frequency / digital				
Rotor moment of inertia (J_R)	kgm ² x10 ⁻⁶	19	19	38	38	57
Function for motor protection at stall	Ω	thermal				
Overload protection		Integrated				
Permissible ambient temperature range (T_U)	°C	0 ... +40	0 ... +40	0 ... +40	0 ... +40	0 ... +40
Weight	kg	0.85	0.85	1.15	1.15	1.50
Part number	IP 40	932 6320 403	932 6320 405	932 6340 403	932 6340 405	932 6360 405
Part number	IP 54	932 6320 400	932 6320 402	932 6340 400	932 6340 402	932 6360 402

¹⁾The degree of protection refers to the installed condition with sealing on the flange side

The shaft geometry in the IP54 version is different from the displayed sketch

²⁾At T_U max. 40 °C

Preferred type: ready to ship in 48 hours

Subject to alternations

A ECI-63.20-K4, 24 V (at 25 °C)

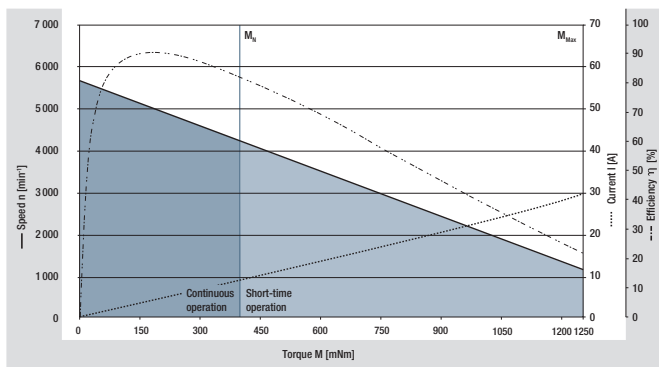

Characteristic curve 48 V on request

B ECI-63.40-K4, 24 V (at 25 °C)

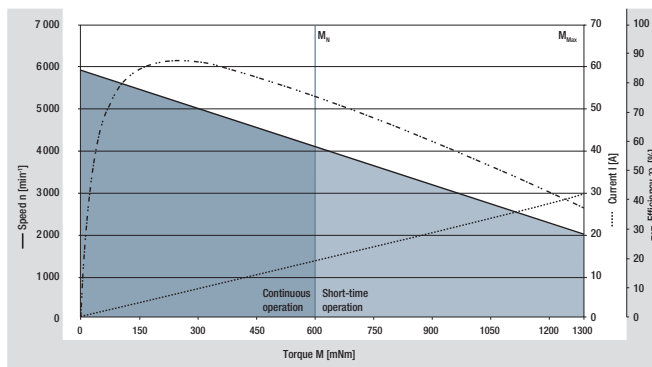

Characteristic curve 48 V on request

C ECI-63.60-K4, 48 V (at 25 °C)

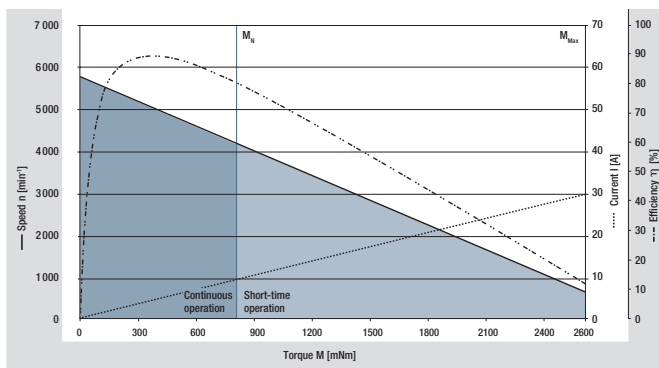

Modular system

Brake system

Spring-applied Integrated
Brake module ECI 63

Basic motor

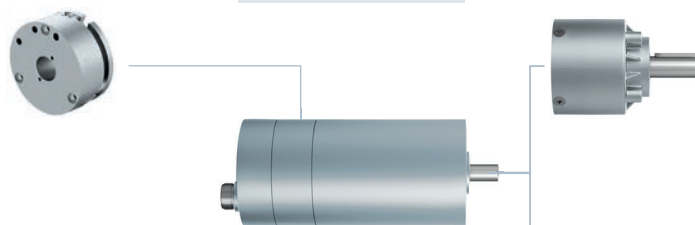

Planetary gearhead

NoiselessPlus 63
Performax®Plus 63
Optimax 63

Commissioning tool

"driveSTUDIO" Page 26

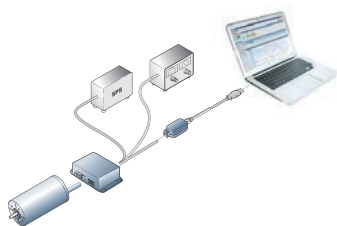

Crown gearheads

EtaCrown® 75
EtaCrown®Plus 63

Cable

Connection cables have to be ordered separately Page 17

For motor-gearbox combinations, depending on the choice of the single components, the maximum allowable torque (gearbox) can be exceeded or respectively not reached.

Technical drawing

All dimensions in mm

Type	L	ØD
ECI-63.20	118.5±0.4	6 _{g5}
ECI-63.40	138.5±0.4	6 _{g5}
ECI-63.60	158.5±0.4	10 _{g5}

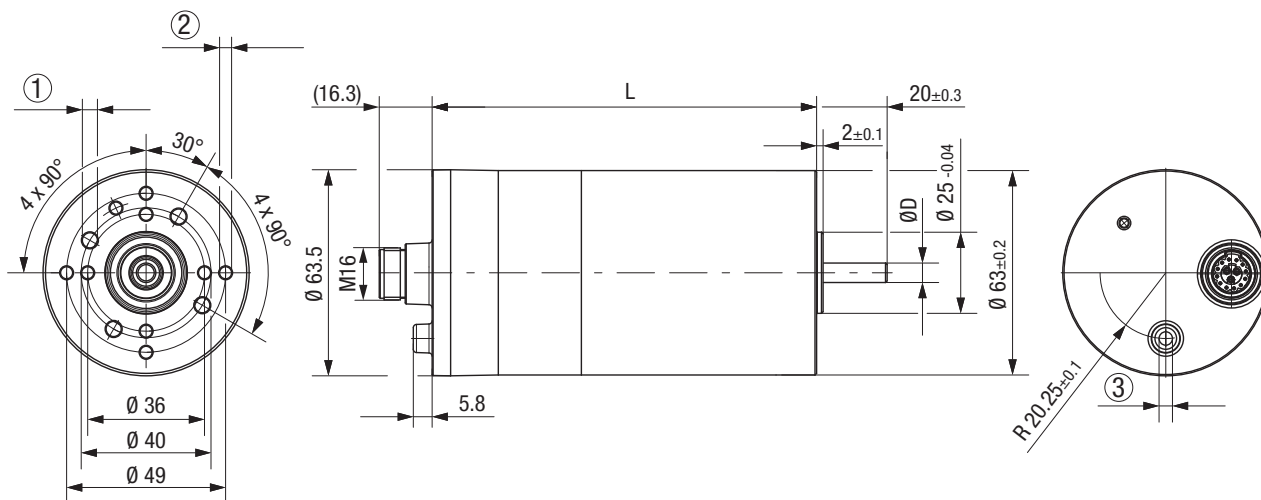

- ① 4 x for thread-forming screws M5 according to DIN7500, screw-in depth max. 10 mm
- ② 8 x for thread-forming screws M4 according to DIN7500, screw-in depth max. 10 mm
- ③ M5, 5 mm

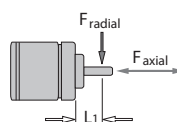

Permissible shaft load

F _{axial} :	150 N	Permissible simultaneous shaft loads at rated speed and service life expectancy L ₁₀ (in rated operation) from 20 000 h (at T _U max. 40 °C)
F _{radial} :	150 N	
L ₁ :	20 mm	

Electrical connection

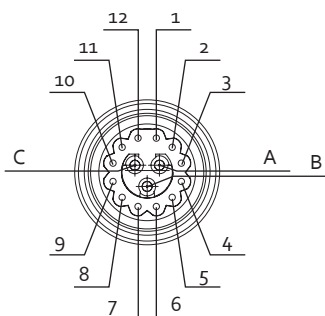

	Pin	Wire color	Configuration	Function	recommended AWG
Signal	1	white	D-IN-A	Digital input A	24
	2	brown	D-IN-B	Digital input B	
	3	green	D-IN-1	Digital input 1	
	4	yellow	D-IN-2	Digital input 2 Analog 0 ... 10 V / brake	
	5	gray	D-OUT-1	Digital output 1	
	6	pink	D-OUT-2	Digital output 2	
	7	blue	D-OUT-3	Digital output 3	
	8	red	A-IN-1	0 ... 10 V (differential)	
	9	black	A-IN-GND	Ground for analog IN 1 (differential)	
	10	violet	RS485 A (+)	Prog.-bus	
	11	gray / pink	RS485 B (-)	Prog.-bus	
	12	red / blue	U _{Logic}	Logic power supply (24 V)	
Power	A	gray	Ballast	Ballast resistor	16
	B	brown	U _{ZK}	Power supply	
	C	black	GND	Power- / signal-ground	

Subject to alternations

Electrical connection Cable

All dimensions in mm

Type	L	Part number
Cable (12 + 3 Pins)	1 000 ± 30	992 0160 034
Cable (12 + 3 Pins)	3 000 ± 30	992 0160 035

Type	L	Part number
Cable (12 + 3 Pins)	1 000 ± 30	992 0160 036
Cable (12 + 3 Pins)	3 000 ± 30	992 0160 037

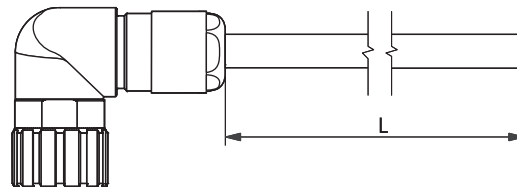
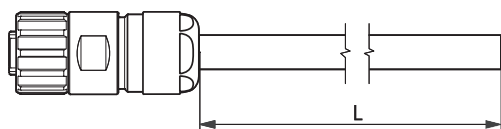

For self-assembly, cables can be obtained from Hummel:

Hummel cable connector M16 for cable Ø 8-11 mm, Tightening torque: 5 Nm (Order no. 7.810.500.000)

Hummel crimp insert series M16, socket 12+3 with special coding (Order no. 7K11886034)

Hummel crimp contact socket 3 x, power, crimp range 0.5 - 1.5 mm² (Order no. 7.010.981.202)

Hummel crimp contact socket 12 x, signal, crimp range 0.08 - 0.34 mm² (Order no. 7.010.980.802)



K1 servomotor in combination with external control electronics

ebmpapst

the engineer's choice

	Page
ECI-80.XX-K1	20
VTD-XX.XX-K4S (position)	21

Servomotor ECI-80.XX-K1

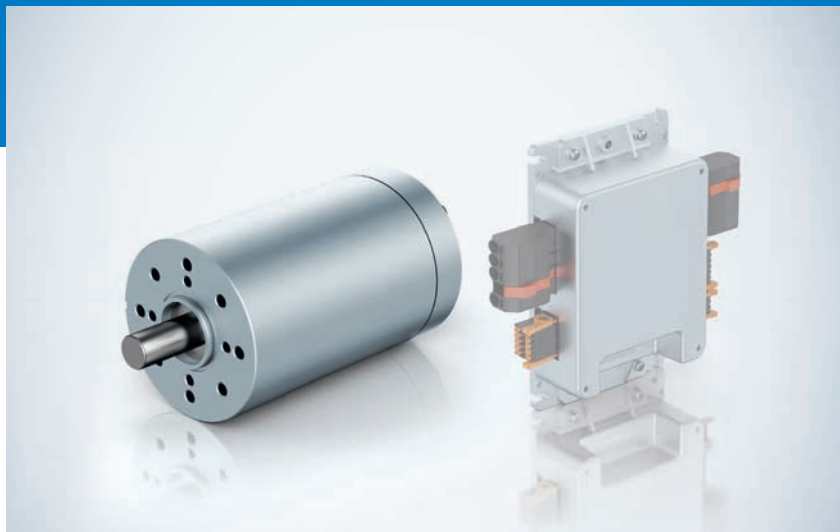

Description

- 3-phase BLDC internal rotor servomotor
- Low cogging torque
- Robust, noise-optimized ball bearing system for a long service life
- High efficiency and high power density realized in a compact design
- Protection class IP 40/IP 54 and connection by connector system
- Basic motor with electronic module K1 for operation with external control electronics
- Mechanical design and interfaces designed for modular flexibility

More at

www.ebmpapst.com/eci-motoren

Type		ECI-80.20-K1 -B00	ECI-80.20-K1 -D00	ECI-80.40-K1 -B00	ECI-80.40-K1 -D00	ECI-80.60-K1 -D00
Characteristic curve		A		B		C
Nominal voltage (U_N)	V DC	24	48	24	48	48
Nominal speed (n_N) ²⁾	rpm	4 000	4 000	4 000	4 000	4 000
Nominal torque (M_N) ²⁾	mNm	700	700	1 200	1 200	1 800
Nominal current (I_N) ²⁾	A	13.5	7.50	25.0	12.0	18.0
Nominal output power (P_N) ²⁾	W	293	293	503	503	754
Starting torque (M_A)	mNm	2 400	2 500	3 900	5 000	5 600
Permissible peak current (I_{max}) ³⁾	A	100	60	100	100	100
Permanent stall torque (M_{NO})	mNm	700	700	1 200	1 200	1 800
Speed at no-load operation (n_L)	rpm	4 800	4 800	4 700	4 850	6 100
No-load current (I_L)	A	1.00	0.70	1.50	0.90	1.00
Recommended speed control range	rpm	0 ... 4 000	0 ... 4 000	0 ... 4 000	0 ... 4 000	0 ... 4 000
Rotor moment of inertia (J_R)	kgm ² x10 ⁻⁶	54	54	104	104	155
Motor constant (K_E)	mVs/rad	47.2	94.1	48.2	96.0	72.2
Connection resistance (R_V)	Ω	0.07	0.30	0.03	0.10	0.04
Connection inductance (L_V)	mH	300	1300	200	600	200
Overload protection		integrated	integrated	integrated	integrated	integrated
Permissible ambient temperature range (T_U)	°C	-30 ... +40	-30 ... +40	-30 ... +40	-30 ... +40	-30 ... +40
Weight	kg	1.40	1.40	2.10	2.10	2.70
Part number (wire interface) ¹⁾	IP 40	932 8020 103	932 8020 105	932 8040 103	932 8040 105	932 8060 105
Part number (cable routing) ¹⁾	IP 54	on request	on request	on request	on request	on request

¹⁾ The degree of protection refers to the installed condition with sealing on the flange side
The shaft geometry in the IP54 version is different from the displayed sketch

²⁾ At T_U max. 40 °C

³⁾ Permissible maximum current duration: max. 5 seconds – can be repeated after complete cool down

Preferred type: ready to ship in 48 hours

Subject to alternations

Control electronics VTD-XX.XX-K4S

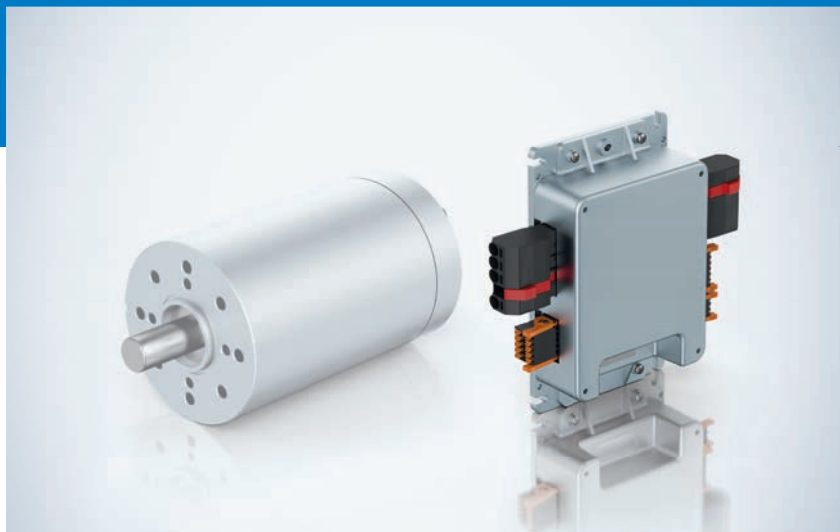

Description

- Operating electronics for driving 3-phase BLDC servomotors up to 1 000 watt output power
- Four-quadrant controller
- Speed, torque and positioning mode
- Selection of operating modes and parameter setting via RS 485
- User-friendly parameter setting with "driveSTUDIO" PC software
- Integrated brake ballast-control
- Device status notification by 1 LED

More at www.ebmpapst.com/eci-motoren

Control electronics

Type		VTD-24.40-K4S	VTD-48.20-K4S
Nominal voltage (power supply U_N)	V DC	24	48
Permissible supply voltage range (U)	V DC	18 ... 30	18 ... 30
Maximum output current (max. 5 sec) ¹⁾	A	100	100
Permissible continuous output current ¹⁾	A	40	40
Nominal voltage (Logic supply U_L)	V DC	24	24
Logic current draw (at 24 V DC) ²⁾	mA	< 100	< 100
Maximum commutation frequency	kHz	2	2
Switching frequency	kHz	20	20
Minimum connection inductance	mH	0.10	0.10
Digital inputs	Number	4	4
Digital outputs	Number	3	3
Analog inputs	Number	1	1
Parameterization interface		RS485	RS485
Efficiency (in optimum working range)	%	> 95	> 95
Permissible ambient temperature range (T_U)	°C	-30 ... +40	-30 ... +40
Permissible ambient humidity ³⁾	%	5 ... 85	5 ... 85
Protection class		IP 20	IP 20
Weight	kg	ca. 0.50	ca. 0.50
Order number (IP 20)		994 2440 000	994 4820 000

¹⁾ Applicable at rated temperature $T_U=25^\circ\text{C}$, Derating at deviating (higher) temperatures

²⁾ Current draw without current requirement of digital outputs

³⁾ Condensation not permitted

Preferred type: ready to ship in 48 hours

Subject to alternations

Technical drawing

All dimensions in mm

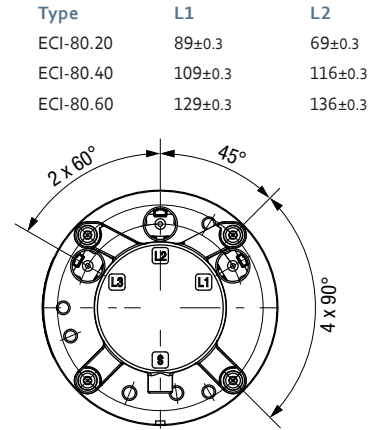
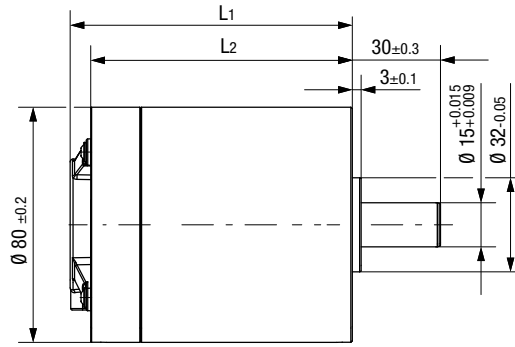
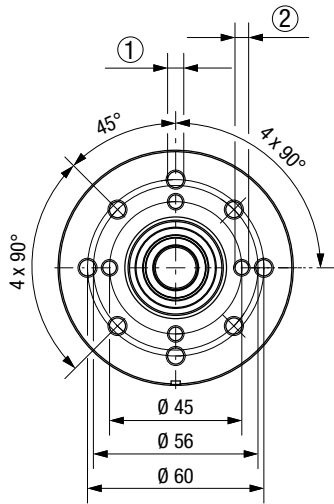

Type	L1	L2
ECI-80.20	89±0.3	69±0.3
ECI-80.40	109±0.3	116±0.3
ECI-80.60	129±0.3	136±0.3

- ① 8 x for thread-forming screws M6 according DIN7500, screw-in depth max. 13 mm
- ② 4 x for thread-forming screws M5 according DIN7500, screw-in depth max. 13 mm

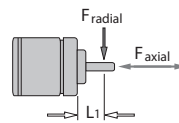

Permissible shaft load

F_{axial} :	70 N	Permissible simultaneous shaft loads at rated speed and service life expectancy L_{10} (in rated operation) from 20 000 h (at T_u max. 40 °C)
F_{radial} :	330 N	
L_1 :	15 mm	

Electrical connection wire

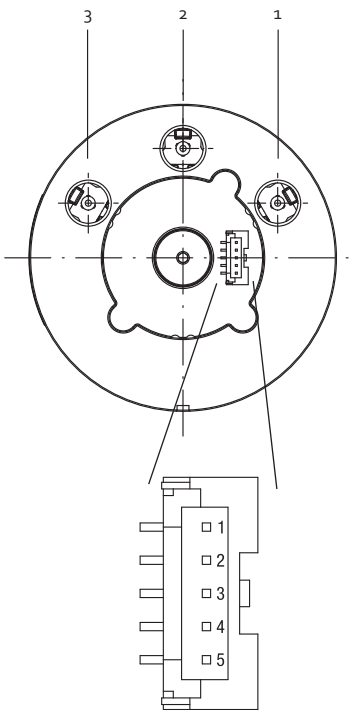

	Pin	Wire color	Configuration	Function	recommended AWG
Power	1	brown	U	Winding connector U	12
	2	violet	V	Winding connector V	
	3	yellow	W	Winding connector W	

	Pin	Wire color	Configuration	Function	recommended AWG
Signal	1	red	U_b	supply voltage	24
	2	black	GND	Ground Hall	
	3	green	Hall A	Hall signal A	
	4	white	Hall B	Hall signal B	
	5	gray	Hall C	Hall signal C	

Electrical connection cable

All dimensions in mm

Motor side

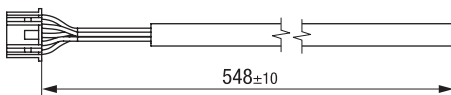

Type	Part number	AWG
Sensor cable with mating plug	992 0800 001	24

Motor side

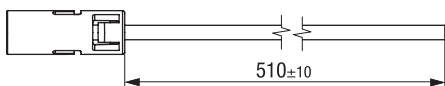

Type	Wire color	Part number	AWG
Winding connection lead U	brown	992 0800 012	12
Winding connection lead V	violet	992 0800 011	
Winding connection lead W	yellow	992 0800 010	

A ECI-80.20-K1, 24 V (at 25 °C)

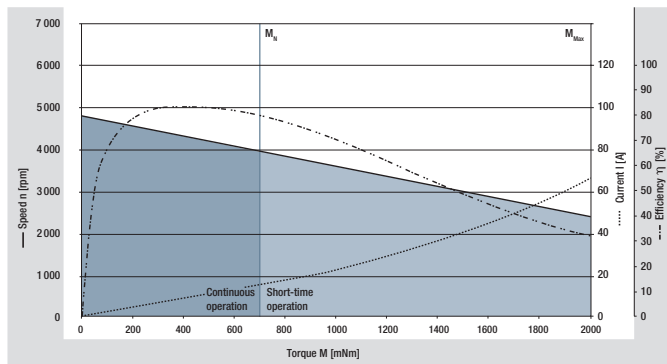

Characteristic curve 48 V on request

B ECI-80.40-K1, 24 V (at 25 °C)

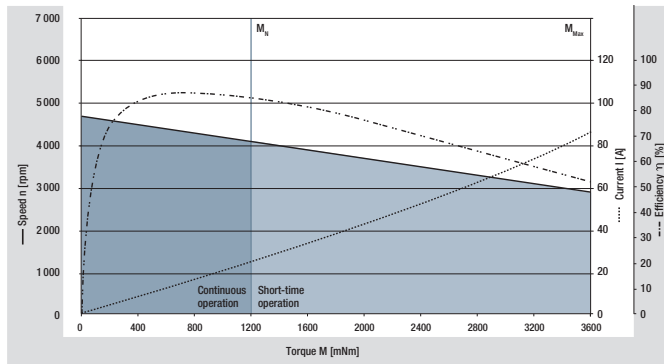

Characteristic curve 48 V on request

C ECI-80.60-K1, 48 V (at 25 °C)

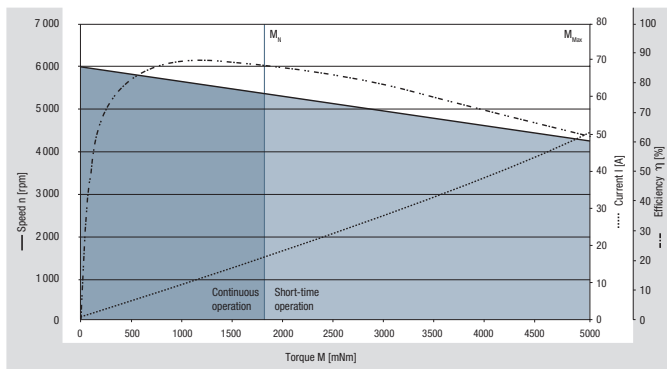

Modular system

Brake system
on request

Basic motor

Planetary gearhead
Performax®Plus 63
Optimax 63

Encoder system
on request

Recommended external control electronics
VTD-XX.XX-K4S speed

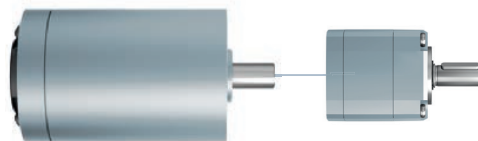

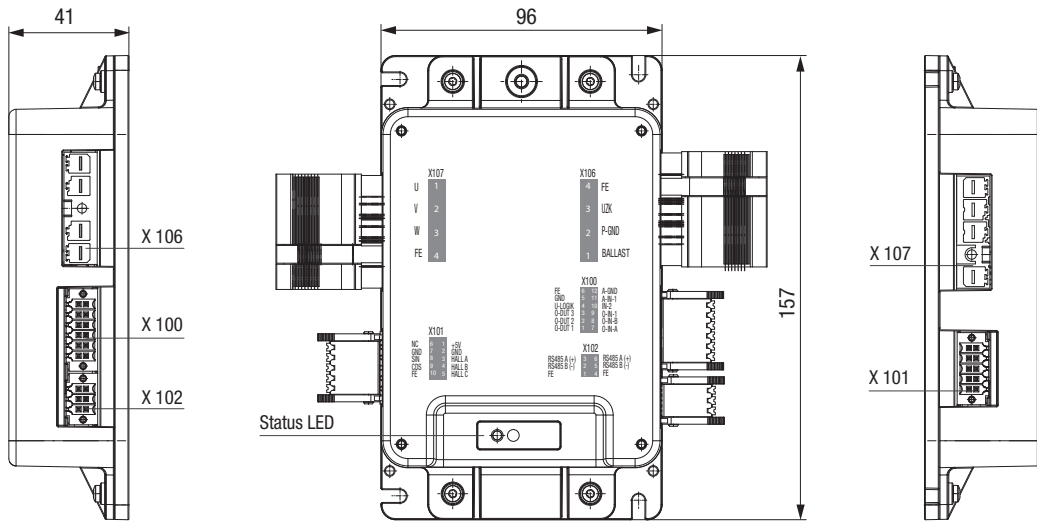

Mating connectors are included in delivery

Accessories

Commissioning tool
„driveSTUDIO“ (page 26)

„drivesSTUDIO“ PC software for commissioning/ parametrization of the drive controller

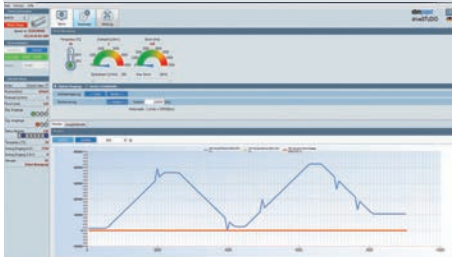
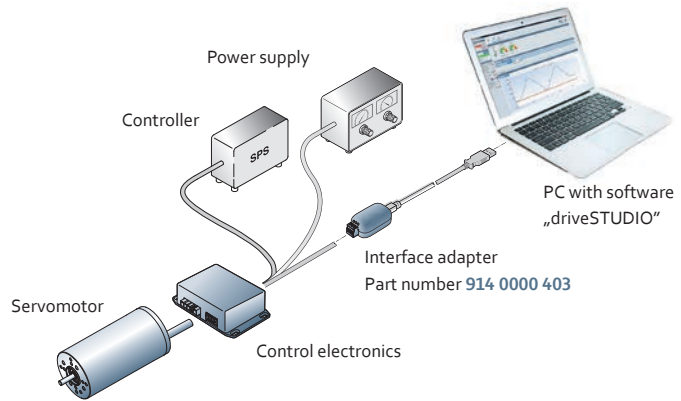

Image of „driveSTUDIO“ PC-Software



Arrangement Commissioning

Commissioning tools K4 drives

Parameterization and commissioning

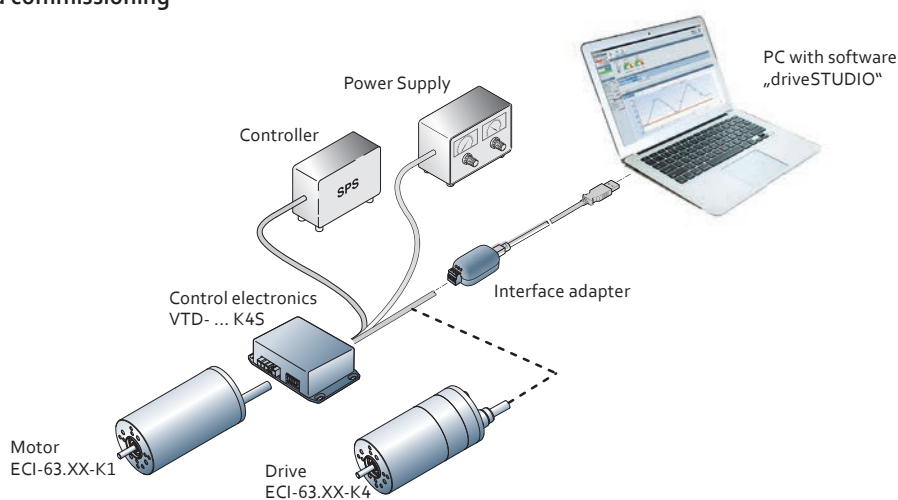

The RS485 interface serves as an interface for parameterization and diagnosis. It can be operated using the freely available "driveSTUDIO" PC software. This requires a PC and the ebm-papst USB-RS485 adapter. Load your detailed operating manual and the PC software "driveSTUDIO" under www.ebmpapst.com.



Interface adapter for „driveSTUDIO“ PC software	Part number
USB-RS485-adapter	914 0000 403

Electrical connection	
PIN	Configu- ration
A	RS485+
B	RS485-
X	--

Functional description of the LED displays

LED name	Color	Display	Function assignment
TxD	red	flashes	Flashes with outgoing message
		does not light up	No outgoing message
RxD	green	flashes	Flashes with outgoing message
		does not light up	No outgoing message
ON	orange	lights up	Normal operation

Easy integration into PROFINET® networks

The SIEMENS ET 200SP allows easy integration of our K4 drivers in the Profinet networks via communication module CM PtP

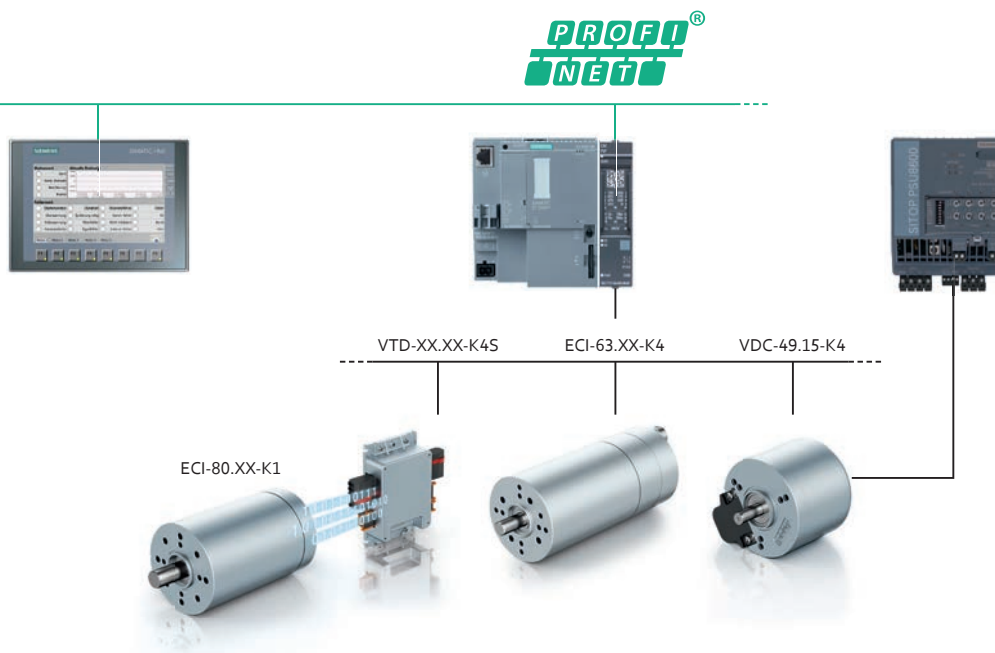

Advantages

- Automatic parameterization of the drive (K4 knowledge not required)
- Automatic controller setting
- Application setting in physical values
- Various statistics and diagnostic information
- Speed/position commands
- Automatic determination of the start-up time using integrated mechatronic model
- HMI control displays allow intuitive interaction

Schematic layout

- The RS485 interface available on the compact drive allows integration into Profinet networks
- Functional components allow simple contro



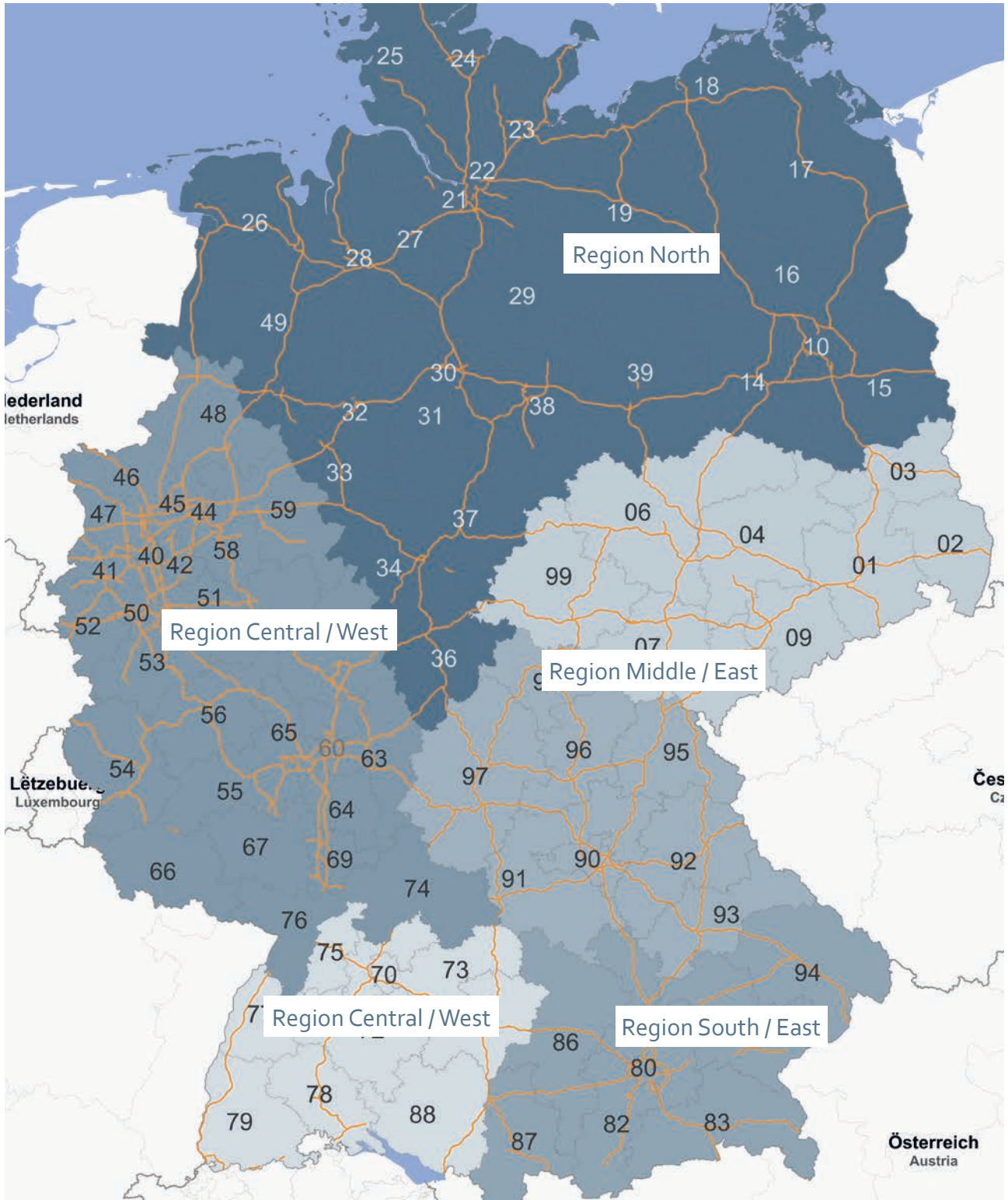

Regions in Germany









Agents

Agents around the world

Germany

-  **Northern region**
Norderstedt
Breuell & Hilgenfeldt GmbH
Udo Wildenblanck
Regionalleitung Vertrieb Antriebstechnik
Oststraße 96
22844 Norderstedt
Phone +49 9123 945-7291
Fax +49 9123 945-5291
Udo.Wildenblanck@de.ebmpapst.com
-  **Central / Ost region**
ebm-papst St. Georgen GmbH & Co. KG
Werk 7- Lauf
Florian Sonnenberg
Industriestraße 9
91207 Lauf a.d. Pegnitz
Phone +49 9123 945-7295
Fax +49 9123 945-5295
Info4@de.ebmpapst.com
Florian.Sonnenberg@de.ebmpapst.com
-  **Central / Western region**
Hemsbach
Markus Psik
Am Dreispitz 16
69502 Hemsbach
Phone +49 9123 945-7293
Fax +49 9123 945-5293
Markus.Psik@de.ebmpapst.com
-  **Southern / Western region**
Ihringen
Mario Rudmann
Hauptstraße 27
79241 Ihringen
Phone +49 9123 945-7294
Fax +49 9123 945-5294
Mario.Rudmann@de.ebmpapst.com
-  **Southern / Eastern region 2**
Baierbrunn
Patrick Christleven
Bernhard-Pankok-Weg 4
82065 Baierbrunn
Phone +49 9123 945-7203
Fax +49 9123 945-5203
Patrick.Christleven@de.ebmpapst.com

Europe

-  **Austria**
ebm-papst Motoren & Ventilatoren GmbH
Straubingstraße 17
4030 Linz
Phone +43 732 321150-0
Fax +43 732 321150-20
info@at.ebmpapst.com
www.ebmpapst.at
-  **Benelux**
ebm-papst Benelux B.V.
Polbeemd 7 – 5741 TP Beek en Donk
P.O. Box 140 – 5740 AC Beek en Donk
Phone +31 492 502-900
Fax +31 492 502-950
verkoop@nl.ebmpapst.com
www.ebmpapst.nl
-  **France**
ebm-papst sarl
Parc d'Activités Nord
1 rue Mohler – BP 62
67212 Obermai Cedex
Phone +33 3 88 66 88 03
info@ebmpapst.fr
www.ebmpapst.fr
-  **Great Britain**
ebm-papst UK Ltd.
Chelmsford Business Park
Chelmsford Essex CM2 5EZ
UNITED KINGDOM
Phone +44 1245 468555
Fax +44 1245 466336
sales@uk.ebmpapst.com
www.ebmpapst.co.uk
-  **Italy**
ebm-papst Srl
Via Cornaggia 108
22076 Mozzate (Co)
Phone +39 0331 8362013
Fax +39 0331 821510
info@it.ebmpapst.com
www.ebmpapst.it
-  **Russland**
ebm-papst Rus GmbH
Olimpiyskiy prospect 29A, office 418
141006 Mytistschi, Oblast Moskau
Phone +7 495 9807524
Fax +7 795 5140924
info@ebmpapst.ru
www.ebmpapst.ru

-  **Sweden**
ebm-papst AB
Äggelundavägen 2
17562 Järfälla
Phone +46 10 4544400
Fax +46 8 362306
info@ebmpapst.se
www.ebmpapst.se

-  **Switzerland**
ebm-papst AG
Rütisbergstraße 1t
8156 Oberhasli
Phone +47 44 73220-70
Fax +41 44 73220-77
verkauf@ebmpapst.ch
www.ebmpapst.ch

America

-  **USA**
ebm-papst Inc.
P.O. Box 4009
100 Hyde Road
Farmington, CT 06034
UNITED STATES
Phone +1 860 674-1515
Fax +1 860 674-8536
sales@us.ebmpapst.com
www.ebmpapst.us

Asia

-  **China**
ebm-papst Ventilator (Shanghai) Co., Ltd
No. 418, Huajing Road
WaiGaoQiao Free Trade Zone
200131 Shanghai
Phone +86 21 5046-0183
Fax +86 21 5046-1119
sales@cn.ebmpapst.com
www.ebmpapst.com.cn
-  **Indien**
ebm-papst India Pvt. Ltd.
26/3, G.N.T. Road Erukkencherry
600 118 Chennai
Phone +91 44 26720103
Fax +91 44 25371149
sales@in.ebmpapst.com
www.ebmpapst.in

 motor specialist

 motor agent

ebmpapst

the engineer's choice

**ebm-papst St. Georgen
GmbH & Co. KG
Hauptverwaltung**

Hermann-Papst-Straße 1
78112 St. Georgen
GERMANY
Phone +49 7724 81-0
Fax +49 7724 81-1309
info2@de.ebmpapst.com

**ebm-papst St. Georgen
GmbH & Co. KG
Werk 7 Lauf**

Industriestraße 9
91207 Lauf a. d. Pegnitz
GERMANY
Phone +49 9123 945-0
Fax +49 9123 945-145
info4@de.ebmpapst.com